

SWITCHING
 N-CHANNEL POWER MOS FET
 INDUSTRIAL USE

DESCRIPTION

This product is Dual N-Channel MOS Field Effect Transistor designed for power management application of notebook computers, and Li-ion battery application.

FEATURES

- Dual MOS FET chips in small package
- 2.5-V gate drive type and low on-resistance
 $R_{DS(on)1} = 30 \text{ m}\Omega \text{ MAX. (} V_{GS} = 4.5 \text{ V, } I_D = 3.0 \text{ A)}$
 $R_{DS(on)2} = 40 \text{ m}\Omega \text{ MAX. (} V_{GS} = 2.5 \text{ V, } I_D = 3.0 \text{ A)}$
- Low C_{iss} $C_{iss} = 800 \text{ pF TYP.}$
- Built-in G-S protection diode
- Small and surface mount package (Power SOP8)

ORDERING INFORMATION

PART NUMBER	PACKAGE
μ PA1756G	Power SOP8

PACKAGE DRAWING (Unit : mm)

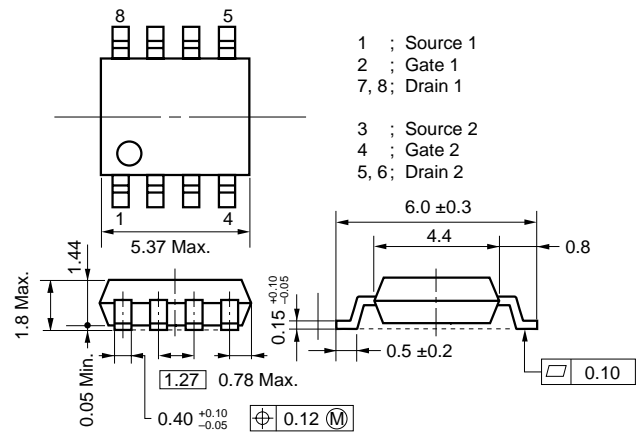

ABSOLUTE MAXIMUM RATINGS ($T_A = 25 \text{ }^\circ\text{C}$)

Drain to Source Voltage ($V_{GS} = 0 \text{ V}$)	V_{DSS}	20	V
Gate to Source Voltage ($V_{DS} = 0 \text{ V}$)	V_{GSS}	±12.0	V
Drain Current (DC)	$I_{D(DC)}$	±6.0	A
Drain Current (Pulse) ^{Note1}	$I_{D(pulse)}$	±24	A
Total Power Dissipation (1 unit) ^{Note2}	P_T	1.7	W
Total Power Dissipation (2 unit) ^{Note2}	P_T	2.0	W
Channel Temperature	T_{ch}	150	$^\circ\text{C}$
Storage Temperature	T_{stg}	-55 to +150	$^\circ\text{C}$

EQUIVALENT CIRCUIT

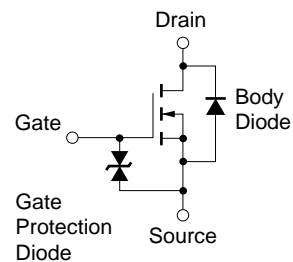

Notes 1. $PW \leq 10 \text{ } \mu\text{s}$, Duty Cycle $\leq 1 \%$

2. $T_A = 25 \text{ }^\circ\text{C}$, Mounted on ceramic substrate of $2000 \text{ mm}^2 \times 1.1 \text{ mm}$

The diode connected between the gate and source of the transistor serves as a protector against ESD. When this device actually used, an additional protection circuit is externally required if a voltage exceeding the rated voltage may be applied to this device.

The information in this document is subject to change without notice. Before using this document, please confirm that this is the latest version.
 Not all devices/types available in every country. Please check with local NEC representative for availability and additional information.

ELECTRICAL CHARACTERISTICS (T_A = 25 °C)

CHARACTERISTICS	SYMBOL	TEST CONDITIONS	MIN.	TYP.	MAX.	UNIT
Drain to Source On-state Resistance	R _{DS(on)1}	V _{GS} = 4.5 V, I _D = 3.0 A		20.0	30	mΩ
	R _{DS(on)2}	V _{GS} = 2.5 V, I _D = 3.0 A		25.8	40	mΩ
Gate to Source Cut-off Voltage	V _{GS(off)}	V _{DS} = 10 V, I _D = 1.0 mA	0.5	0.7	1.5	V
Forward Transfer Admittance	y _{fs}	V _{DS} = 10 V, I _D = 3.0 A	4.0	12		S
Drain Leakage Current	I _{DSS}	V _{DS} = 20 V, V _{GS} = 0 V			10	μA
Gate to Source Leakage Current	I _{GSS}	V _{GS} = ±12.0 V, V _{DS} = 0 V			±10	μA
Input Capacitance	C _{iss}	V _{DS} = 10 V		800		pF
Output Capacitance	C _{oss}	V _{GS} = 0 V		360		pF
Reverse Transfer Capacitance	C _{rss}	f = 1 MHz		70		pF
Turn-on Delay Time	t _{d(on)}	I _D = 3.0A		110		ns
Rise Time	t _r	V _{GS(on)} = 4.0 V		425		ns
Turn-off Delay Time	t _{d(off)}	V _{DD} = 10 V		1050		ns
Fall Time	t _f	R _G = 10 Ω		1200		ns
Total Gate Charge	Q _G	I _D = 6.0 A		11		nC
Gate to Source Charge	Q _{GS}	V _{DD} = 16 V		2.0		nC
Gate to Drain Charge	Q _{GD}	V _{GS} = 4.0 V		4.6		nC
Body Diode Forward Voltage	V _{F(S-D)}	I _F = 6.0 A, V _{GS} = 0 V		0.8		V

TEST CIRCUIT 1 SWITCHING TIME

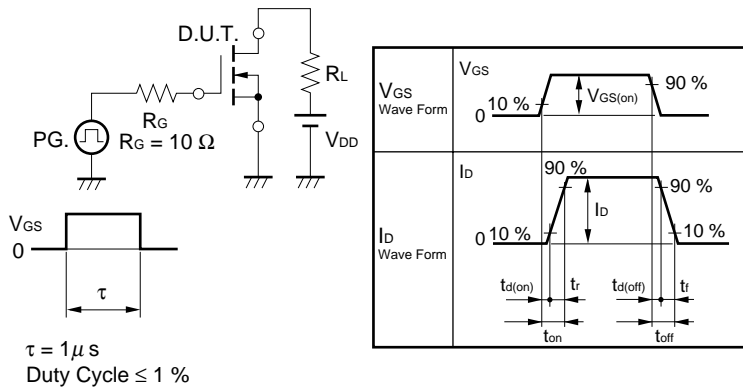

TEST CIRCUIT 2 GATE CHARGE

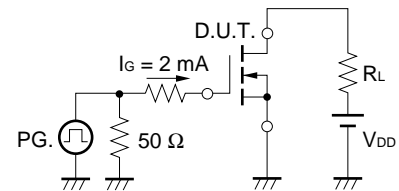

TYPICAL CHARACTERISTICS ($T_A = 25^\circ\text{C}$)

TRANSIENT THERMAL RESISTANCE vs. PULSE WIDTH

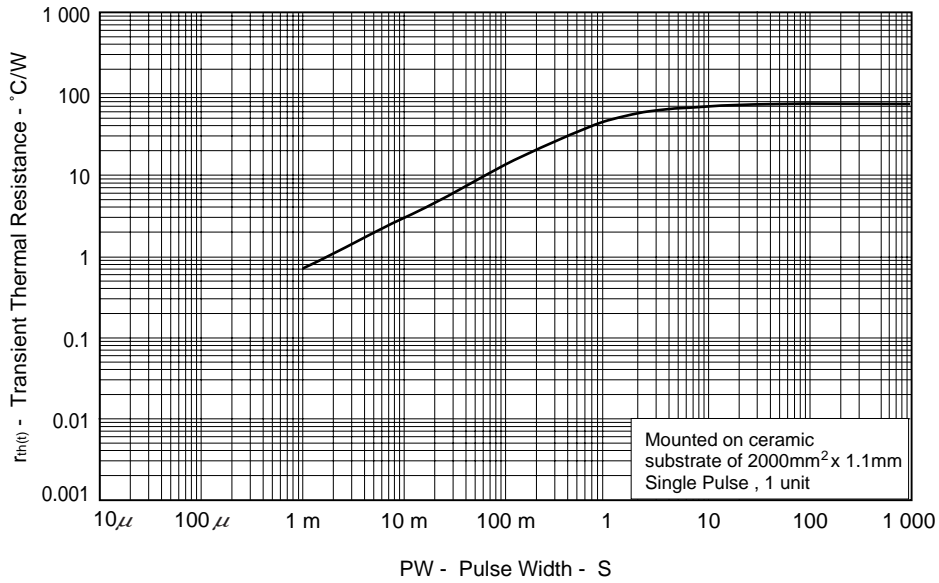

FORWARD TRANSFER ADMITTANCE vs. DRAIN CURRENT

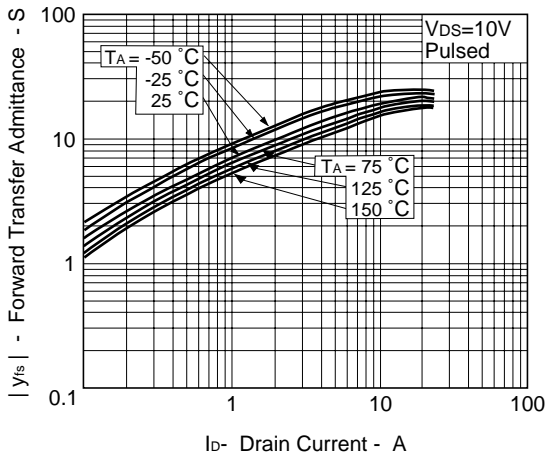

DRAIN TO SOURCE ON-STATE RESISTANCE vs. GATE TO SOURCE VOLTAGE

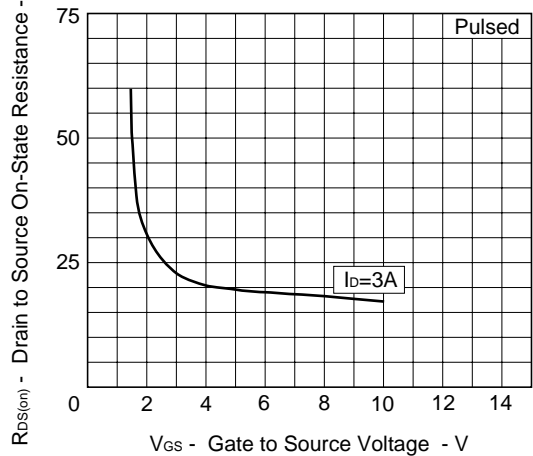

DRAIN TO SOURCE ON-STATE RESISTANCE vs. DRAIN CURRENT

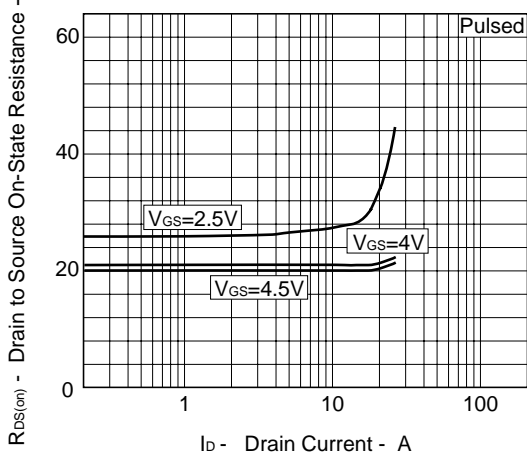

GATE TO SOURCE CUT-OFF VOLTAGE vs. CHANNEL TEMPERATURE

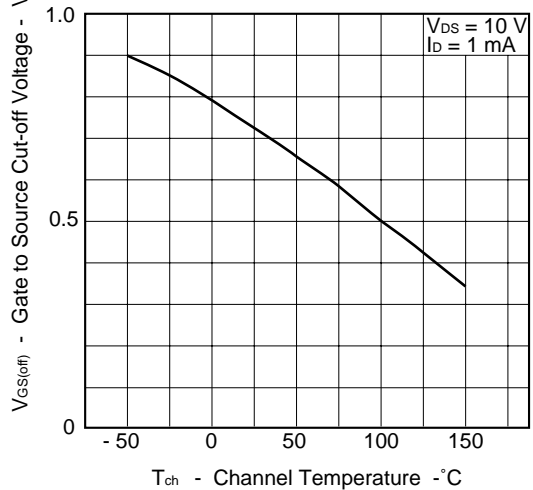

DRAIN TO SOURCE ON-STATE RESISTANCE vs. CHANNEL TEMPERATURE

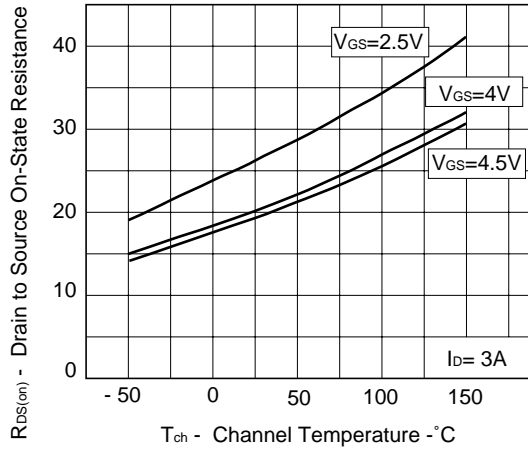

SOURCE TO DRAIN DIODE FORWARD VOLTAGE

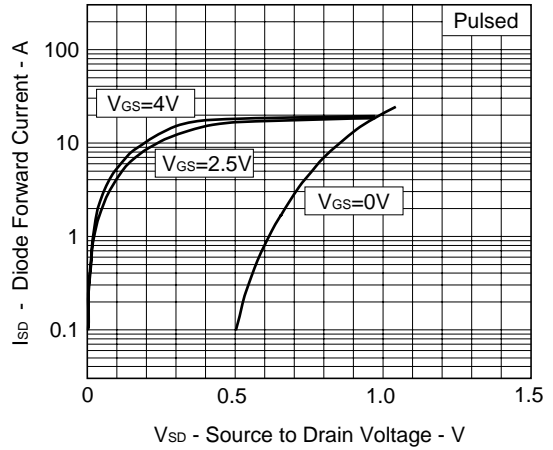

CAPACITANCE vs. DRAIN TO SOURCE VOLTAGE

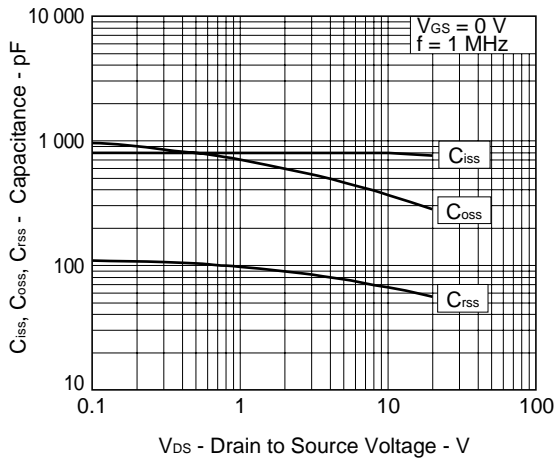

SWITCHING CHARACTERISTICS

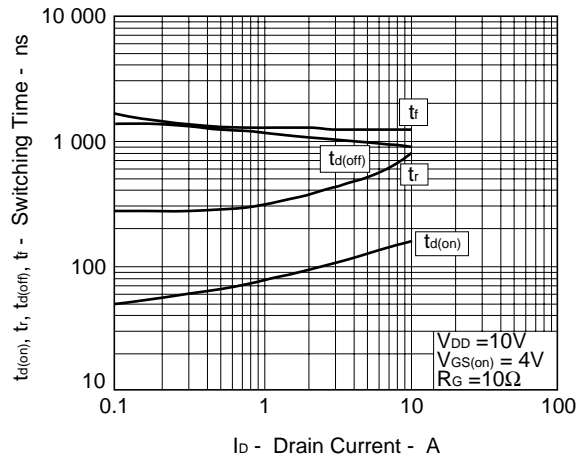

DYNAMIC INPUT/OUTPUT CHARACTERISTICS

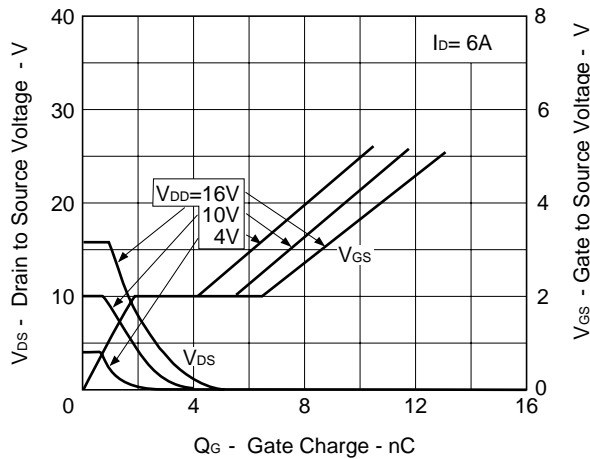

DERATING FACTOR OF FORWARD BIAS SAFE OPERATING AREA

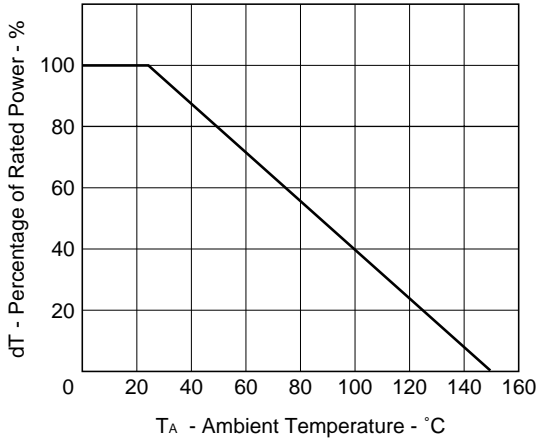

TOTAL POWER DISSIPATION vs. AMBIENT TEMPERATURE

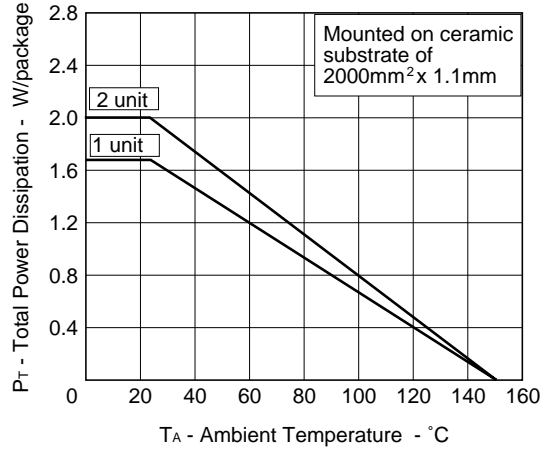

FORWARD BIAS SAFE OPERATING AREA

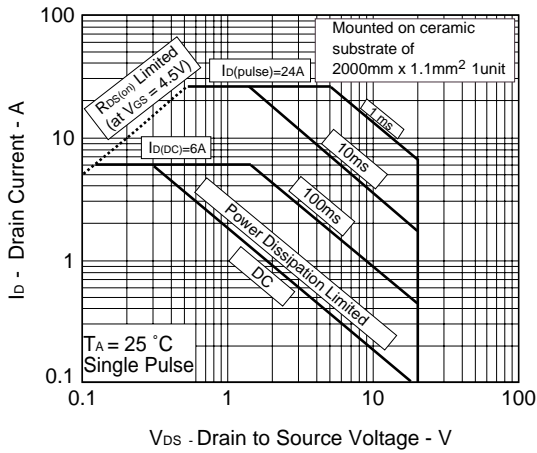

DRAIN CURRENT vs. DRAIN TO SOURCE VOLTAGE

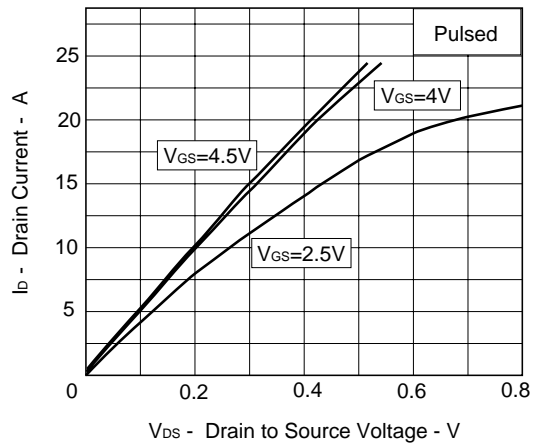

FORWARD TRANSFER CHARACTERISTICS

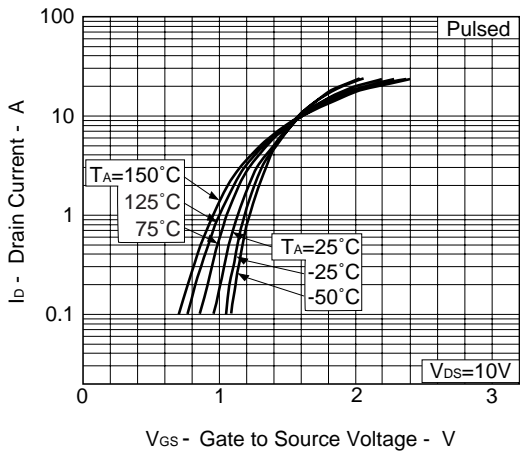

[MEMO]

[MEMO]

- **The information in this document is subject to change without notice. Before using this document, please confirm that this is the latest version.**
 - No part of this document may be copied or reproduced in any form or by any means without the prior written consent of NEC Corporation. NEC Corporation assumes no responsibility for any errors which may appear in this document.
 - NEC Corporation does not assume any liability for infringement of patents, copyrights or other intellectual property rights of third parties by or arising from use of a device described herein or any other liability arising from use of such device. No license, either express, implied or otherwise, is granted under any patents, copyrights or other intellectual property rights of NEC Corporation or others.
 - Descriptions of circuits, software, and other related information in this document are provided for illustrative purposes in semiconductor product operation and application examples. The incorporation of these circuits, software, and information in the design of the customer's equipment shall be done under the full responsibility of the customer. NEC Corporation assumes no responsibility for any losses incurred by the customer or third parties arising from the use of these circuits, software, and information.
 - While NEC Corporation has been making continuous effort to enhance the reliability of its semiconductor devices, the possibility of defects cannot be eliminated entirely. To minimize risks of damage or injury to persons or property arising from a defect in an NEC semiconductor device, customers must incorporate sufficient safety measures in its design, such as redundancy, fire-containment, and anti-failure features.
 - NEC devices are classified into the following three quality grades:
 - "Standard", "Special", and "Specific". The Specific quality grade applies only to devices developed based on a customer designated "quality assurance program" for a specific application. The recommended applications of a device depend on its quality grade, as indicated below. Customers must check the quality grade of each device before using it in a particular application.
 - Standard: Computers, office equipment, communications equipment, test and measurement equipment, audio and visual equipment, home electronic appliances, machine tools, personal electronic equipment and industrial robots
 - Special: Transportation equipment (automobiles, trains, ships, etc.), traffic control systems, anti-disaster systems, anti-crime systems, safety equipment and medical equipment (not specifically designed for life support)
 - Specific: Aircraft, aerospace equipment, submersible repeaters, nuclear reactor control systems, life support systems or medical equipment for life support, etc.
- The quality grade of NEC devices is "Standard" unless otherwise specified in NEC's Data Sheets or Data Books. If customers intend to use NEC devices for applications other than those specified for Standard quality grade, they should contact an NEC sales representative in advance.